

moveXX

driven by brain power



DATASHEET
Movexx T2500-P



Specifications T2500-P

Frame	Steel, powder coated
Drive	24V DC, 600W, 100 rpm
Weight	154 kg
Weight trailer	2500 kg
Battery	Exchangable batterypack
Speed	Max. 3,8 km/h
Drive wheels	Vulcolan ø200x55 mm
Width	478mm
Length	1362mm
Adze height	750-1053 (variable)
Noise level	68,5 dB
To use from	-40 °C / 70 °C
Protection class	Machine IP44
Lifting capacity	1500 kg

Dimensions T2500-P

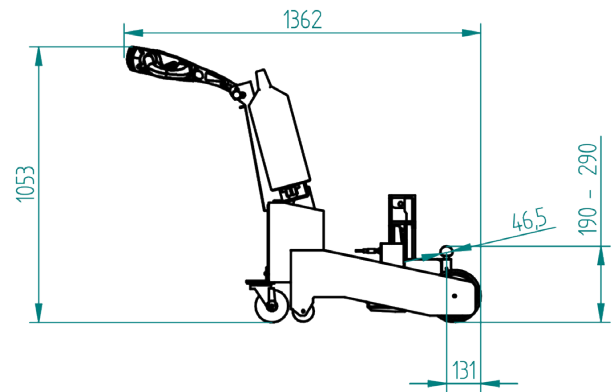
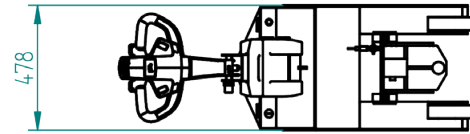

Pulling power T2500-P (in kg)

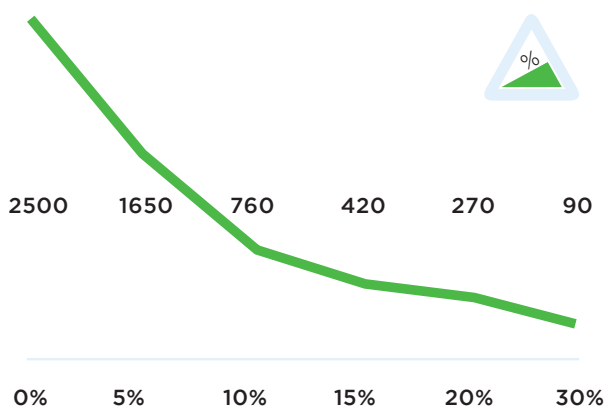

**Measured with a trolley with 2 swivelwheels and 2 fixed castors. Wheel diameter: 160mm*

Standard T2500-P



Standard parts T2500-P

Battery charger Lithium 29,4V-10A



Item number:
OPT0013

Battery Lithium-LiFe-PO4, 36Ah GREEN



Item number:
OPT0106

Drive wheel Ø200 B50 d20 mm



Item number:
M0340

Adjustable tillerhead



Item number:
Standardpart 1

Safety switch



Item number:
Standardpart 2

2 programmable speeds



Item number:
Standardpart 3

Standard parts T2500-P

**Engine 600W
100RPM BRAKE
6911413X**



Item number:
M2098

**LED battery indicator
LBF318-24V**



Item number:
M0123

Options T2500-P



**Built-in Charger 4A
T2500-P surcharge**

Article number:
OPT0222



**Slow speed with load
T2500-P**

Article number:
OPT0019



Horn 90dB

Article number:
OPT0045



**Emergency stop
complete**

Article number:
OPT0063



**Strobelight cast iron
tiller head**

Article number:
OPT0076

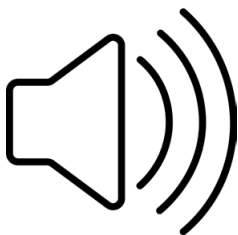

**Acoustic signal dri-
ving backwards**

Article number:
OPT0254



**hour counter com-
plete**

Article number:
OPT0056



Antistatic strip

Article number:
OPT0058



Code lock

Article number:
OPT0068



Document holder

Article number:
OPT0127



**Ignition key unequal
key**

Article number:
OPT0145



**Ignition key equal
key 701**

Article number:
OPT0146

Options T2500-P



Customized program- ming

*please indicate specific
settings*

Article number:
OPT0170



Programmer for Ital- sea

Article number:
D0003



Charging Station for 1 Lithium battery

*Wallmounting charcer-
station with lithium batte-
ry charger 29,2 V, 10 A*

Article number:
OPT0023



Charging station for 5 Lithium batteries

*Upright standing char-
ching station with five
separate lithium battery
chargers 29,2 V, 10 A*

Article number:
OPT0029



Frame for charging station

*for wall mounting, Exclu-
ding charger (!)*

Article number:
OPT0261



25mm higher ball L=145

Article number:
OPT0192

50 mm bigger lifhtight at T2500-P



Article number:
OPT0181

Ball, height: 60mm for T1000-P



Article number:
OPT0183

50 mm higher ball T2500-P



Article number:
OPT0215

Lift module T2500-P 50mm higher/deeper



Article number:
OPT0216

Tow Ball Ø 45mm L = 155mm T1000-P



Article number:
OPT0224

Manual release T2500-P



Article number:
OPT0232

Options T2500-P

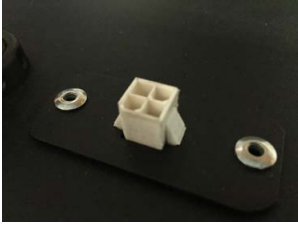

Diagnostic connector

Article number:
OPT0270

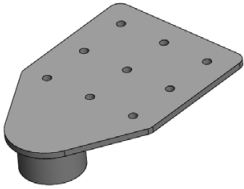

**Screw tube for
T1000-P + T2500-P**

Article number:
OPT0301

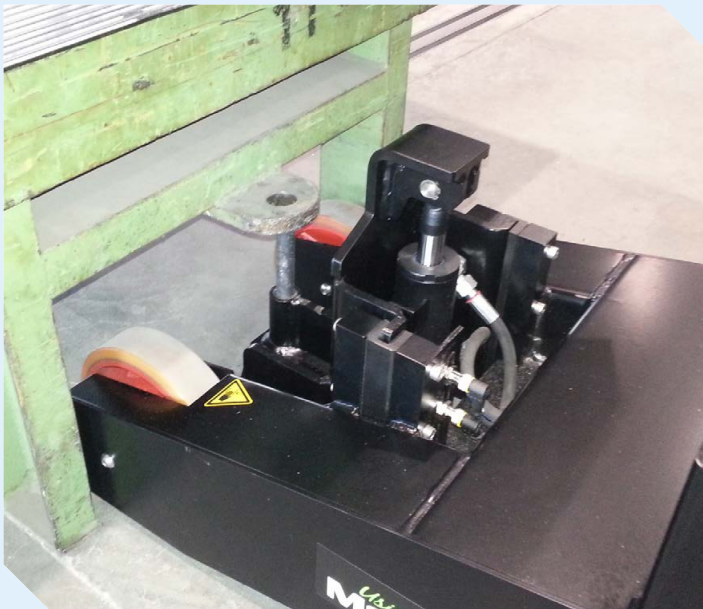
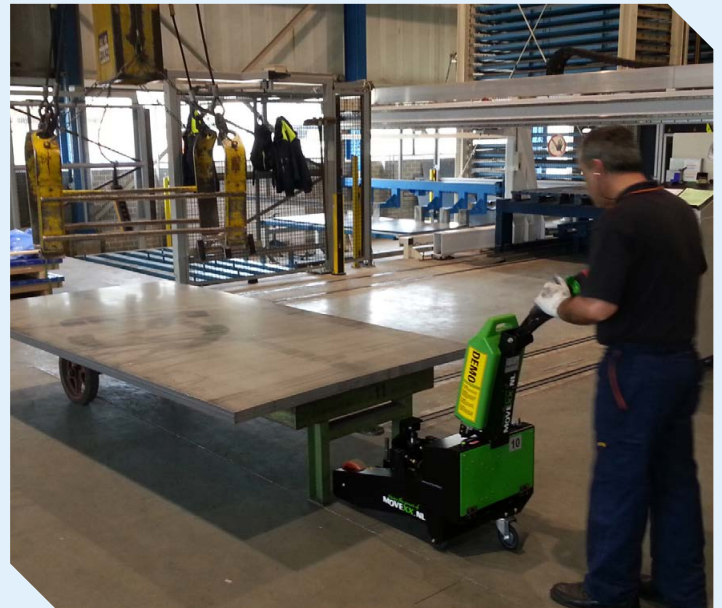

Movexx International B.V.

Generatorstraat 17

3903 LH Veenendaal

Tel +31 (0)318 51.99.00

Fax +31 (0)318 50.80.20

E-mail info@movexx.nl